

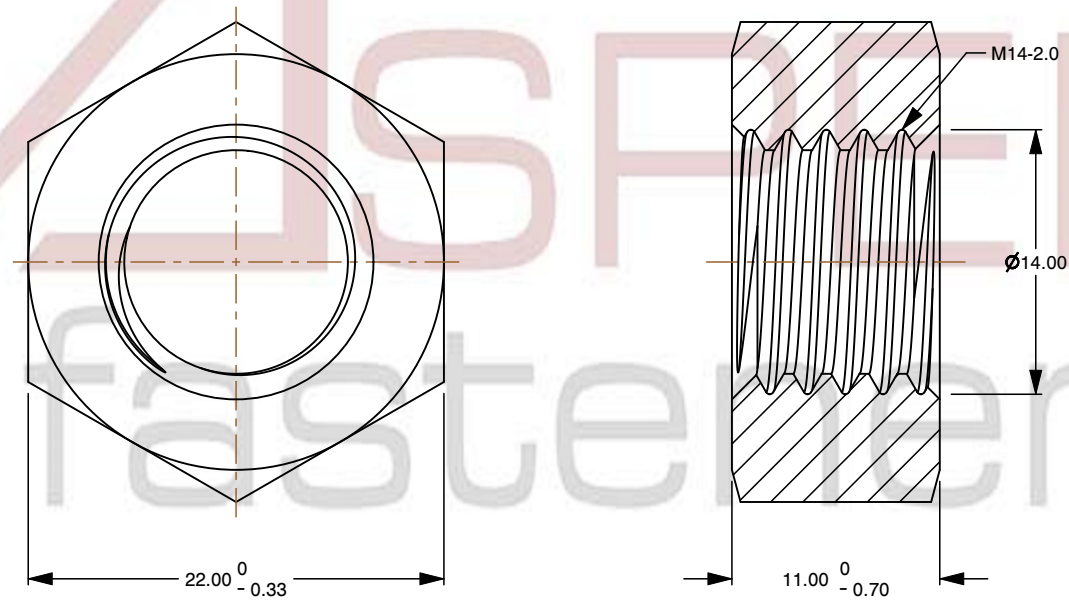

**Specifications for: M14-2.0 DIN 934 / ISO 4032, Metric, Hex Finished Nuts, A4-80 Stainless Steel**

Notes:

- Category: Hex Finished Nuts
- Drive Style: External Hex Drive
- System of Measurement: Metric
- Thread Length: Full Thread
- Thread Direction: Right-Hand Thread
- Material: Stainless Steel
- Material Grade: A4-80 Stainless Steel
- Coating: Uncoated
- Standards and Specifications: DIN 934 / ISO 4032

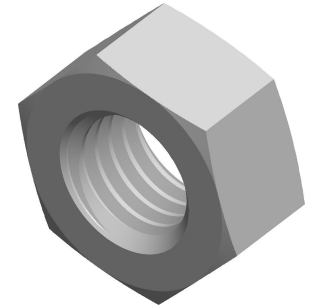

 www.aspenfasteners.com	This file and any associated information and specifications are provided for reference and evaluation purposes only and is subject to change without notice. Aspen Fasteners Inc. makes no representations, warranties, or guarantees as to the appropriateness, accuracy, completeness, or suitability for any purpose of the file, information or specifications. You are solely responsible for the use of the file, information, or specifications.	This document is the property of Aspen Fasteners Inc. and the information it contains may not be reproduced, disclosed, or shared with any third party without the expressed written permission of Aspen Fasteners Inc.	PRODUCT NAME M14-2.0 DIN 934 / ISO 4032, Metric, Hex Finished Nuts, A4-80 Stainless Steel	UNIT MILLIMETERS
			SCALE 2.500	PART NUMBER: ME592-1420X11X22