

**Specifications for: #8-32 X 3-1/4" Machine Screws, Pan Phillips Drive, Full Thread, Steel, Black Oxide**

Notes:

- Category: Machine Screws
- System of Measurement: Inch
- Head Style: Pan Head
- Drive Style: Cruciform Recess Drive
- Drive Detail: Phillips Type H
- Thread Length: Full Thread
- Thread Direction: Right-Hand Thread
- Material: Steel
- Coating: Oxidized
- Coating Color: Black
- Origin: Origin Undefined
- Standards and Specifications: ASME B18.6.3 and SAE J82

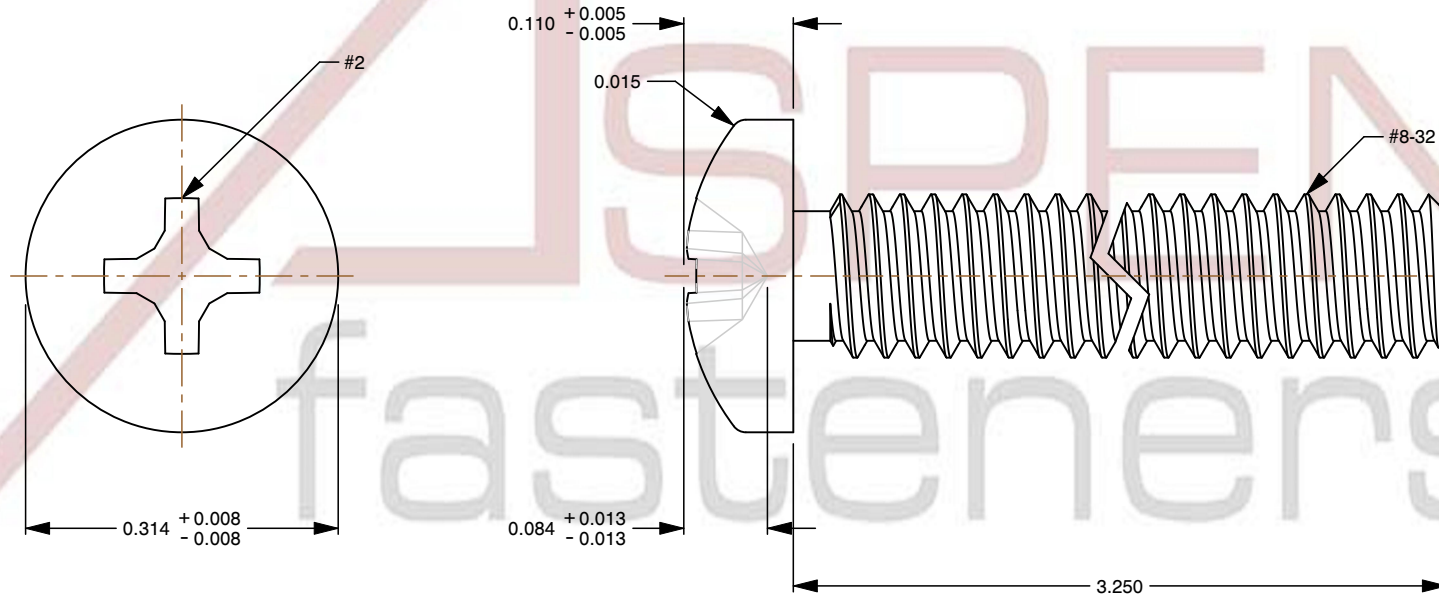
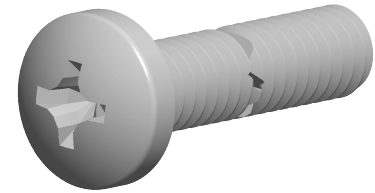

This file and any associated information and specifications are provided for reference and evaluation purposes only and is subject to change without notice. Aspen Fasteners Inc. makes no representations, warranties, or guarantees as to the appropriateness, accuracy, completeness, or suitability for any purpose of the file, information or specifications. You are solely responsible for the use of the file, information, or specifications.

This document is the property of Aspen Fasteners Inc. and the information it contains may not be reproduced, disclosed, or shared with any third party without the expressed written permission of Aspen Fasteners Inc.

SCALE 5.185

PRODUCT NAME  
#8-32 X 3-1/4" Machine Screws, Pan Phillips Drive, Full Thread, Steel, Black Oxide

PART NUMBER: SC147-832X314

UNIT  
INCHES

ISSUED  
2026-06-03

SHEET 1 of 1