

Specifications for: #6-32 X 1/2" Machine Screws, Flat Slot Drive, 82 Degree Countersink, Full Thread, Brass

Notes:

- Category: Machine Screws
- System of Measurement: Inch
- Head Style: Flat Countersunk Head
- Head Style Detail: 82 Degree Countersink
- Drive Style: Slotted Drive
- Thread Length: Full Thread
- Thread Direction: Right-Hand Thread
- Material: Brass
- Coating: Uncoated
- Origin: Origin Undefined

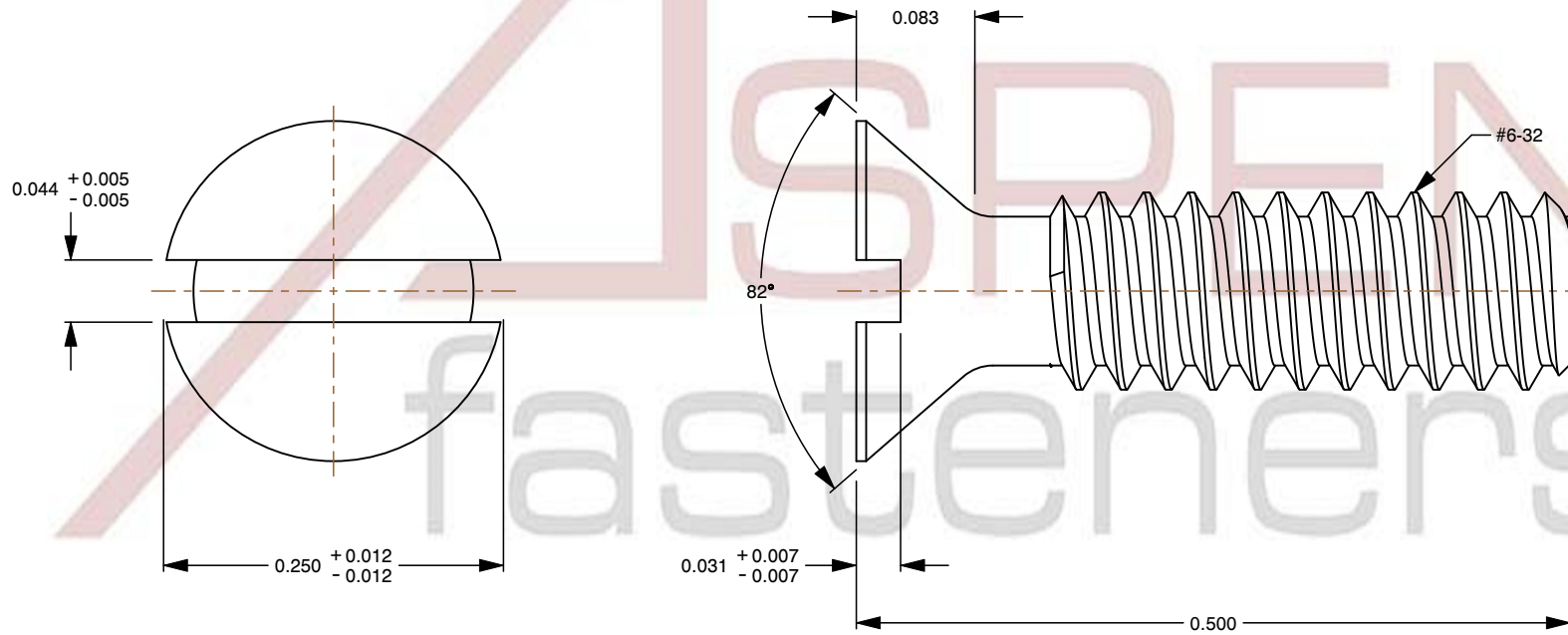
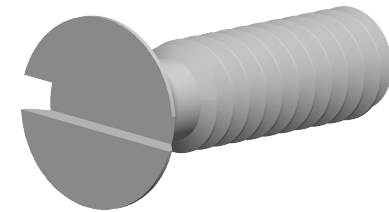

This file and any associated information and specifications are provided for reference and evaluation purposes only and is subject to change without notice. Aspen Fasteners Inc. makes no representations, warranties, or guarantees as to the appropriateness, accuracy, completeness, or suitability for any purpose of the file, information or specifications. You are solely responsible for the use of the file, information, or specifications.

This document is the property of Aspen Fasteners Inc. and the information it contains may not be reproduced, disclosed, or shared with any third party without the expressed written permission of Aspen Fasteners Inc.

SCALE 7.467

PRODUCT NAME
#6-32 X 1/2" Machine Screws, Flat Slot Drive, 82 Degree Countersink, Full Thread, Brass

PART NUMBER: SC557-632X12

UNIT
INCHES

ISSUED
2026-06-03

SHEET 1 of 1