

Specifications for: 5/8"-18 X 5/8" Hex Socket Set Screws, Cup Point, Fine Thread, Full Thread, Alloy Steel

Notes:

- Category: Set Screws
- System of Measurement: Inch
- Head Style: Headless
- Drive Style: Hex Socket Drive
- Pitch: UNRF Fine Thread
- Thread Length: Full Thread
- Thread Direction: Right-Hand Thread
- Point: Cup Point
- Material: Steel
- Material Grade: Alloy Steel
- Coating: Uncoated
- Origin: Origin Undefined
- Standards and Specifications: ANSI B18.3 and ASTM F912

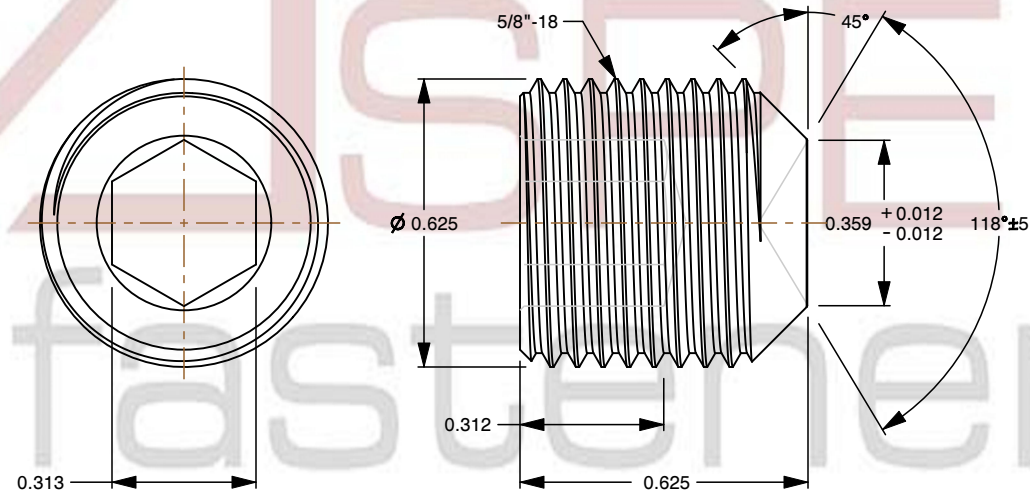
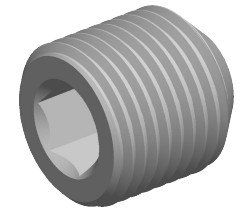

This file and any associated information and specifications are provided for reference and evaluation purposes only and is subject to change without notice. Aspen Fasteners Inc. makes no representations, warranties, or guarantees as to the appropriateness, accuracy, completeness, or suitability for any purpose of the file, information or specifications. You are solely responsible for the use of the file, information, or specifications.

This document is the property of Aspen Fasteners Inc. and the information it contains may not be reproduced, disclosed, or shared with any third party without the expressed written permission of Aspen Fasteners Inc.

SCALE 2.400

PRODUCT NAME
5/8"-18 X 5/8" Hex Socket Set Screws,
Cup Point, Fine Thread, Full Thread, Alloy Steel

PART NUMBER: SO072-5818X58

UNIT
INCHES

ISSUED
2025-06-25

SHEET 1 of 1