

Specifications for: 7/16"-14 X 1-3/4" Hex Head Cap Screws Bolts, Coarse Thread, ASTM A354 Grade BD Alloy Steel, Yellow Zinc and Baked, B1821BH (supersedes MS90727F), DFARS

Notes:

- Category: Cap Screws
- Head Style: Hex Head
- System of Measurement: Inch
- Head Style Detail: Washer Face
- Head Markings: Material Grade Mark "BD"
- Drive Style: External Hex Drive
- Pitch: Coarse Thread
- Thread Direction: Right-Hand Thread
- Point: Chamfered Point
- Material: Steel
- Material Grade: Alloy Steel ASTM A354 Grade BD
- Coating: Zinc Plated and Baked
- Coating Color: Yellow
- Origin: Made in U.S.A.
- Standards and Specifications: ASME B18.2.1.BH, DFARS

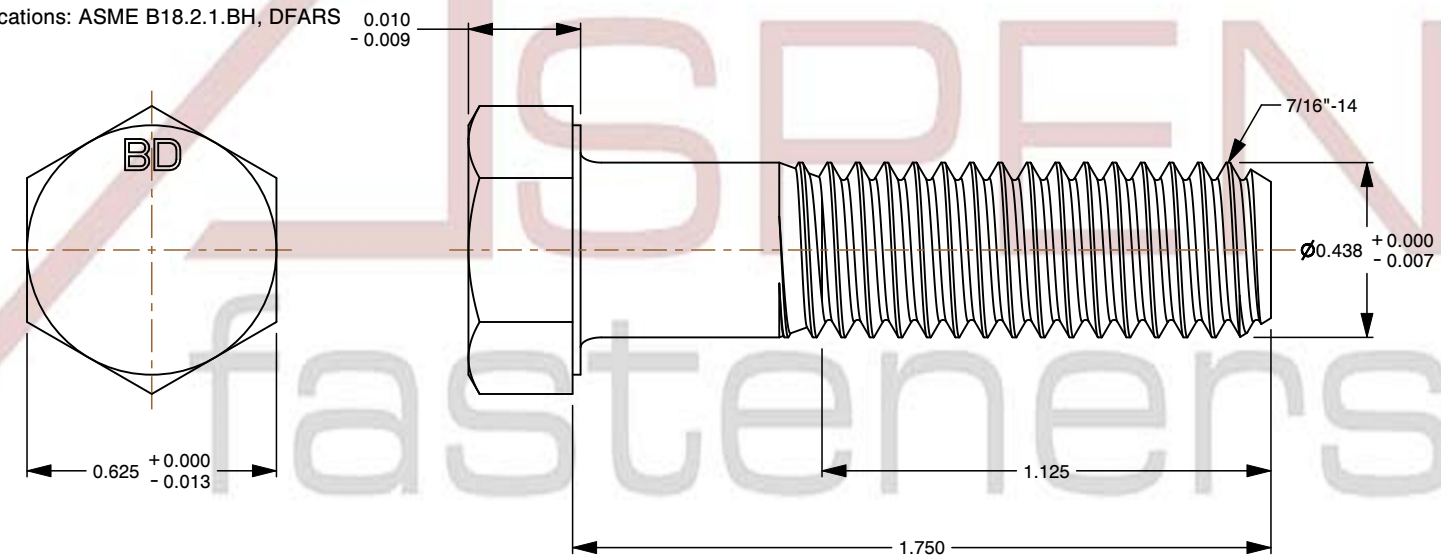
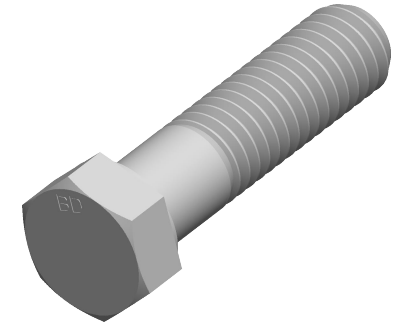

This file and any associated information and specifications are provided for reference and evaluation purposes only and is subject to change without notice. Aspen Fasteners Inc. makes no representations, warranties, or guarantees as to the appropriateness, accuracy, completeness, or suitability for any purpose of the file, information or specifications. You are solely responsible for the use of the file, information, or specifications.

This document is the property of Aspen Fasteners Inc. and the information it contains may not be reproduced, disclosed, or shared with any third party without the expressed written permission of Aspen Fasteners Inc.

SCALE 2.078

PRODUCT NAME
7/16"-14 X 1-3/4" Hex Head Cap Screws Bolts,
Coarse Thread, ASTM A354 Grade BD Alloy Steel,
Yellow Zinc and Baked,
B1821BH (supersedes MS90727F), DFARS

PART NUMBER: MI006-71614X134

UNIT
INCHES

ISSUED
2025-02-20

SHEET 1 of 1