

**Specifications for: 1/2"-13 X 7-1/2" Machine Bolts, Hex Head, Part Thread, A307 Steel, Hot Dip Galvanized**

Notes:

- Category: Machine Bolts
- System of Measurement: Inch
- Head Style: Hex Head
- Drive Style: External Hex Drive
- Body Style: Undersized Body
- Thread Length: Part Thread
- Thread Direction: Right-Hand Thread
- Material: Steel
- Material Grade: A307 Steel
- Coating: Hot Dip Galvanized
- Coating Color: Clear
- Origin: Origin Undefined
- Standards and Specifications: ASME B18.2.1

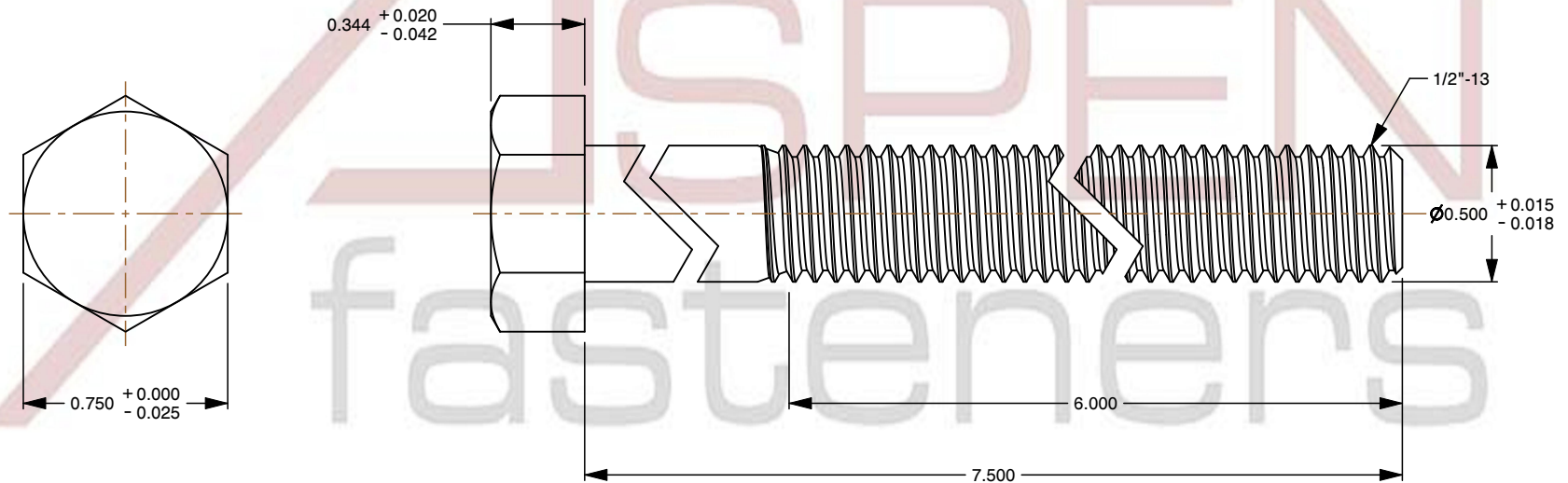
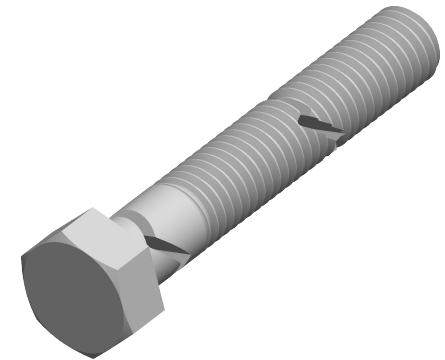

This file and any associated information and specifications are provided for reference and evaluation purposes only and is subject to change without notice. Aspen Fasteners Inc. makes no representations, warranties, or guarantees as to the appropriateness, accuracy, completeness, or suitability for any purpose of the file, information or specifications. You are solely responsible for the use of the file, information, or specifications.

This document is the property of Aspen Fasteners Inc. and the information it contains may not be reproduced, disclosed, or shared with any third party without the expressed written permission of Aspen Fasteners Inc.

SCALE 1.522

PRODUCT NAME  
1/2"-13 X 7-1/2" Machine Bolts, Hex Head,  
Part Thread, A307 Steel, Hot Dip Galvanized

PART NUMBER: BO070-1213X712X6

UNIT  
INCHES

ISSUED  
2025-09-19

SHEET 1 of 1