

Specifications for: M24-3.0 X 90mm DIN 931 / ISO 4014, Metric, Hex Head Cap Screws Bolts, Part Thread, Class 10.9 Steel, Plain

Notes:

- Category: Cap Screws
- Head Style: Hex Head
- System of Measurement: Metric
- Head Style Detail: Washer Face
- Drive Style: External Hex Drive
- Pitch: Coarse Thread
- Thread Length: Part Thread
- Thread Direction: Right-Hand Thread
- Point: Chamfered Point
- Material: Steel
- Material Grade: Class 10.9 Steel
- Material Processes: Quenched and Tempered
- Coating: Uncoated
- Standards and Specifications: DIN 931 / ISO 4014

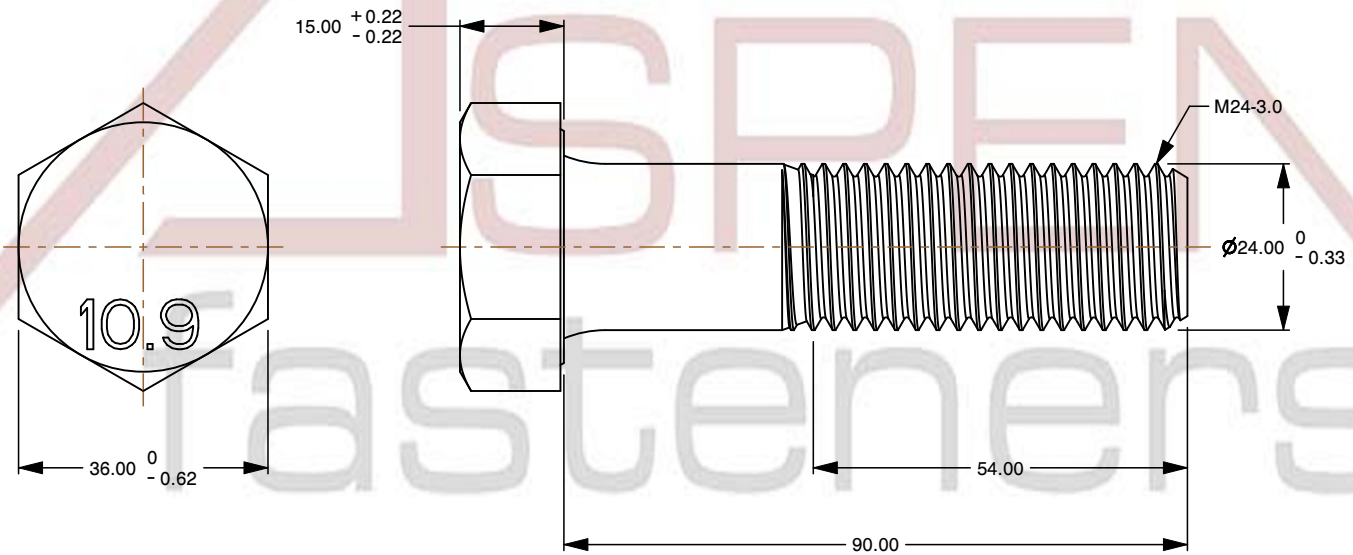
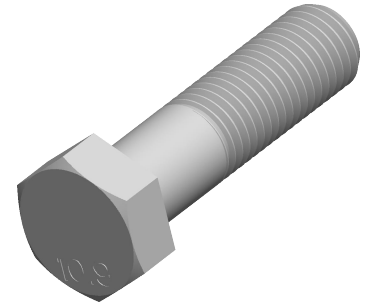

This file and any associated information and specifications are provided for reference and evaluation purposes only and is subject to change without notice. Aspen Fasteners Inc. makes no representations, warranties, or guarantees as to the appropriateness, accuracy, completeness, or suitability for any purpose of the file, information or specifications. You are solely responsible for the use of the file, information, or specifications.

This document is the property of Aspen Fasteners Inc. and the information it contains may not be reproduced, disclosed, or shared with any third party without the expressed written permission of Aspen Fasteners Inc.

SCALE 0.917

PRODUCT NAME
M24-3.0 X 90mm DIN 931 / ISO 4014, Metric,
Hex Head Cap Screws Bolts, Part Thread,
Class 10.9 Steel, Plain

PART NUMBER: ME004-2430X90

UNIT
MILLIMETERS

ISSUED
2025-02-20

SHEET 1 of 1