

**Specifications for: M10-1.5 X 55mm DIN 931 / ISO 4014, Metric, Hex Head Cap Screws Bolts, Part Thread, A4 Stainless Steel**

Notes:

- Category: Cap Screws
- Head Style: Hex Head
- System of Measurement: Metric
- Head Style Detail: Washer Face
- Drive Style: External Hex Drive
- Pitch: Coarse Thread
- Thread Length: Part Thread
- Thread Direction: Right-Hand Thread
- Point: Chamfered Point
- Material: Stainless Steel
- Material Grade: A4 Stainless Steel
- Coating: Uncoated
- Standards and Specifications: DIN 931 / ISO 4014

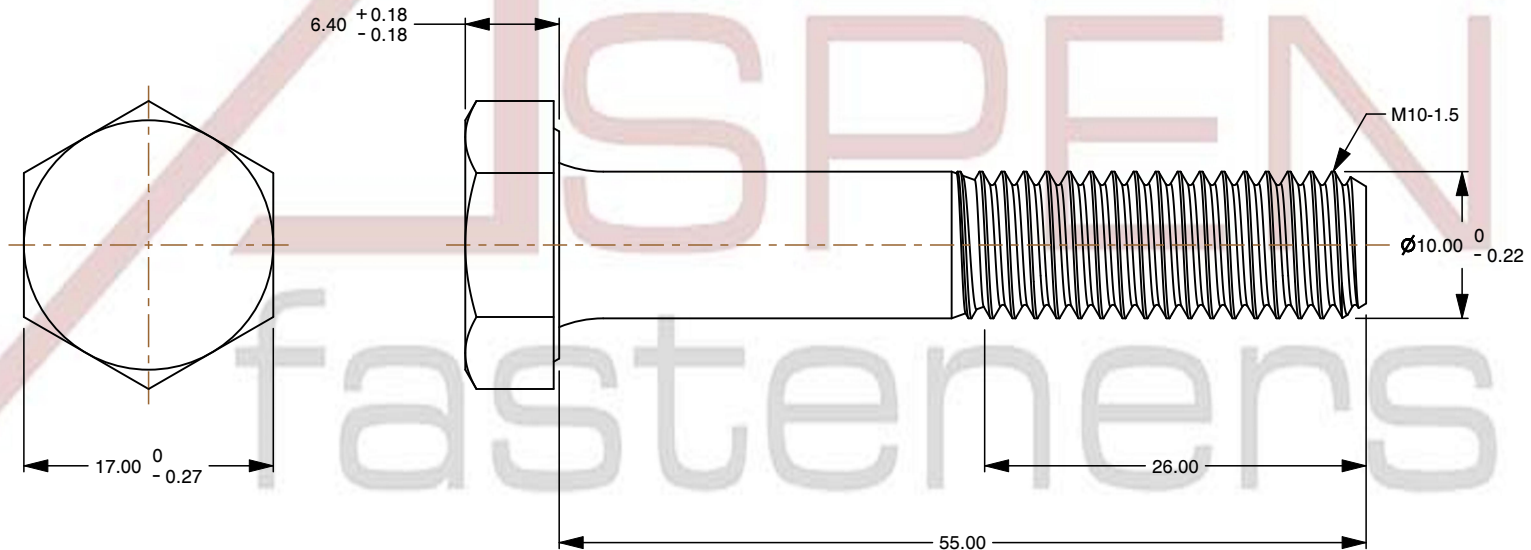
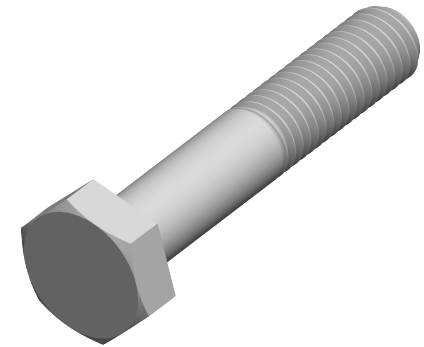

This file and any associated information and specifications are provided for reference and evaluation purposes only and is subject to change without notice. Aspen Fasteners Inc. makes no representations, warranties, or guarantees as to the appropriateness, accuracy, completeness, or suitability for any purpose of the file, information or specifications. You are solely responsible for the use of the file, information, or specifications.

This document is the property of Aspen Fasteners Inc. and the information it contains may not be reproduced, disclosed, or shared with any third party without the expressed written permission of Aspen Fasteners Inc.

SCALE 1.941

PRODUCT NAME  
M10-1.5 X 55mm DIN 931 / ISO 4014, Metric,  
Hex Head Cap Screws Bolts, Part Thread,  
A4 Stainless Steel

PART NUMBER: ME167-1015X55

UNIT  
MILLIMETERS

ISSUED  
2025-02-20

SHEET 1 of 1