

Specifications for: 7/8"-9 X 4-1/2" Hex Head Cap Screws Bolts, UNC Coarse Thread, Grade 8 Steel, Plain

Notes:

- Category: Cap Screws
- Head Style: Hex Head
- System of Measurement: Inch
- Head Style Detail: Washer Face
- Head Markings: Six radial lines 60 degrees apart and manufacturer ID
- Drive Style: External Hex Drive
- Pitch: UNC Coarse Thread
- Thread Direction: Right-Hand Thread
- Point: Chamfered Point
- Material: Steel
- Material Grade: Grade 8
- Coating: Uncoated
- Standards and Specifications: ASME B18.2.1 and SAE J429

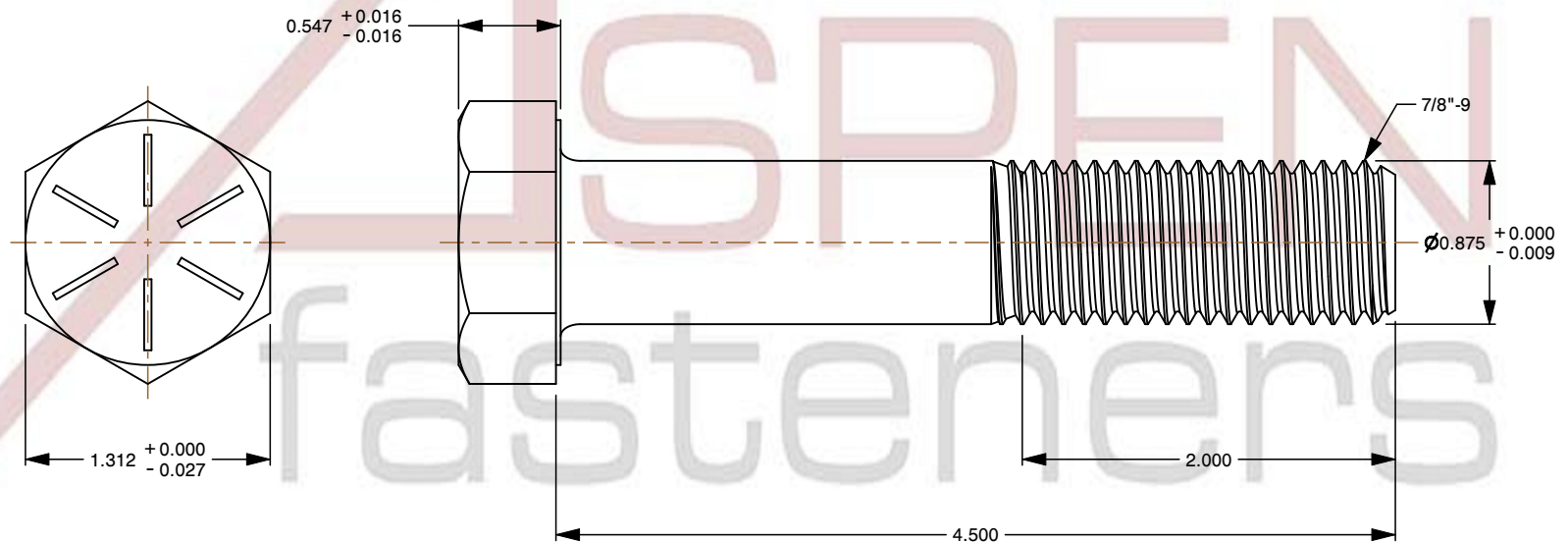
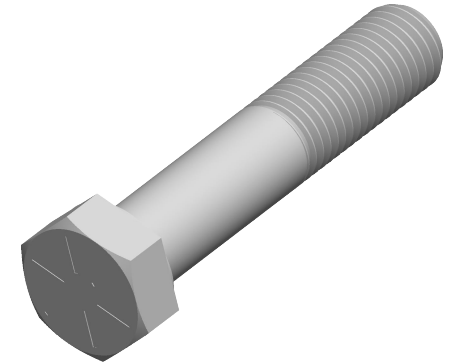

This file and any associated information and specifications are provided for reference and evaluation purposes only and is subject to change without notice. Aspen Fasteners Inc. makes no representations, warranties, or guarantees as to the appropriateness, accuracy, completeness, or suitability for any purpose of the file, information or specifications. You are solely responsible for the use of the file, information, or specifications.

This document is the property of Aspen Fasteners Inc. and the information it contains may not be reproduced, disclosed, or shared with any third party without the expressed written permission of Aspen Fasteners Inc.

SCALE 0.990

PRODUCT NAME
7/8"-9 X 4-1/2" Hex Head Cap Screws Bolts,
UNC Coarse Thread, Grade 8 Steel, Plain

PART NUMBER: BO056-789X412

UNIT
INCHES

ISSUED
2025-01-26

SHEET 1 of 1