

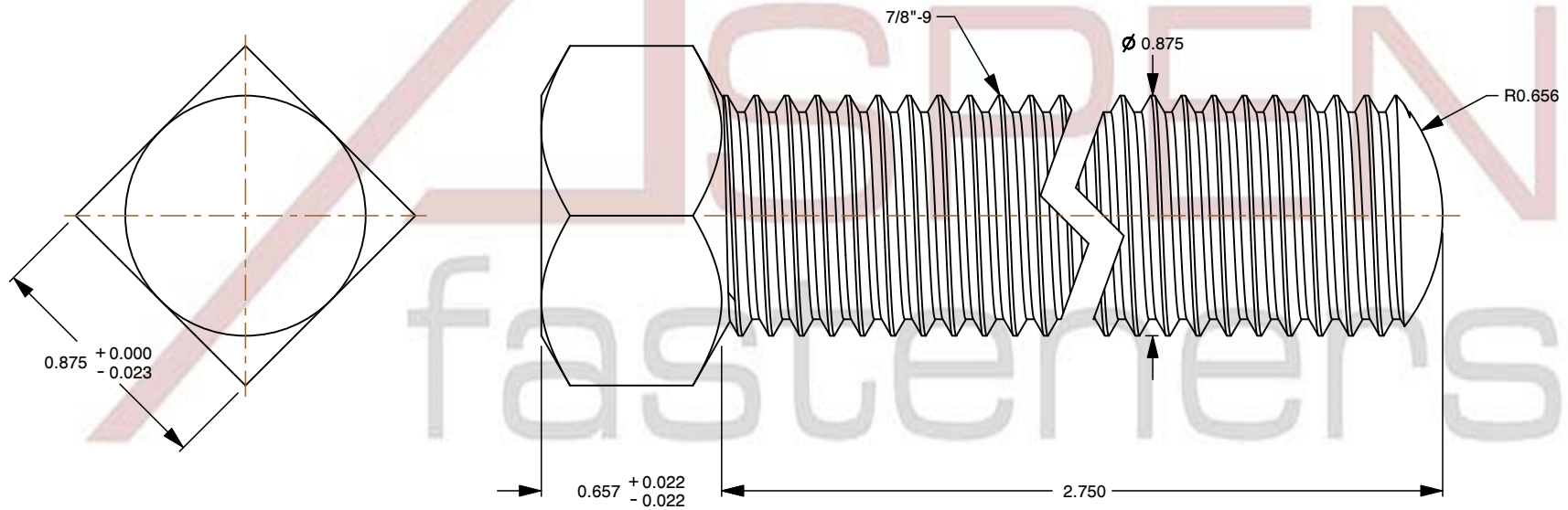

Specifications for: 7/8"-9 X 2-3/4" Set Screws, Square Head, Oval Point, Steel

Notes:

- Category: Set Screws
- System of Measurement: Inch
- Head Style: Square Head
- Drive Style: External Square Drive
- Thread Length: Full Thread
- Thread Direction: Right-Hand Thread
- Point: Oval Point
- Material: Steel
- Material Grade: Low Carbon Steel
- Material Processes: Case Hardened
- Coating: Uncoated
- Origin: Origin Undefined
- Standards and Specifications: ASME B18.6.2

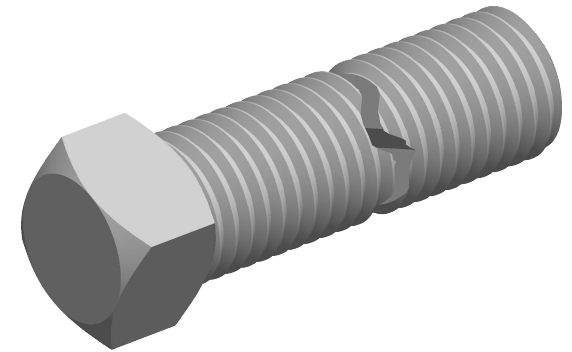

 www.aspenfasteners.com	This file and any associated information and specifications are provided for reference and evaluation purposes only and is subject to change without notice. Aspen Fasteners Inc. makes no representations, warranties, or guarantees as to the appropriateness, accuracy, completeness, or suitability for any purpose of the file, information or specifications. You are solely responsible for the use of the file, information, or specifications.	This document is the property of Aspen Fasteners Inc. and the information it contains may not be reproduced, disclosed, or shared with any third party without the expressed written permission of Aspen Fasteners Inc.	PRODUCT NAME 7/8"-9 X 2-3/4" Set Screws, Square Head, Oval Point, Steel	UNIT INCHES
			PART NUMBER: SO100-789X234	ISSUED 2025-06-25
		SCALE 1.564	SHEET 1 of 1	