

Specifications for: M12-1.0 DIN 439B, Metric, Hex Jam Thin Nuts, A2 Stainless Steel

Notes:

- Category: Hex Jam Thin Nuts
- Form and Design: Double Chamfered
- System of Measurement: Metric
- Drive Style: External Hex Drive
- Thread Length: Full Thread
- Thread Direction: Right-Hand Thread
- Material: Stainless Steel
- Material Grade: A2 Stainless Steel
- Coating: Uncoated
- Standards and Specifications: DIN 439B

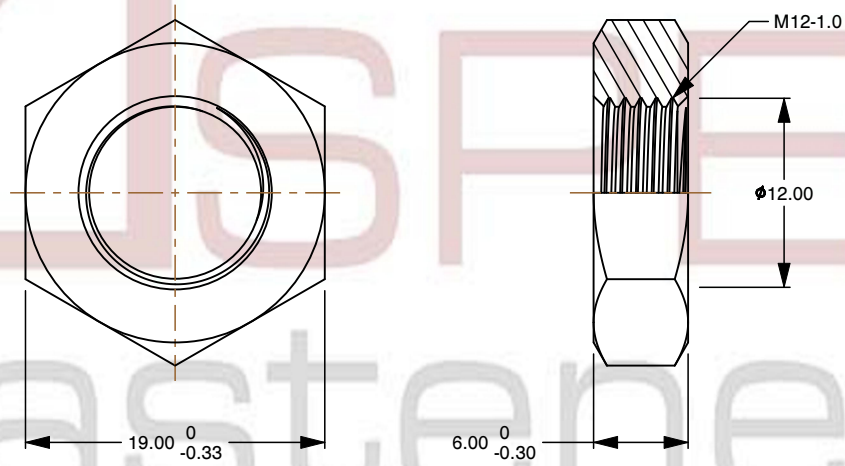
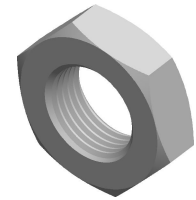

This file and any associated information and specifications are provided for reference and evaluation purposes only and is subject to change without notice. Aspen Fasteners Inc. makes no representations, warranties, or guarantees as to the appropriateness, accuracy, completeness, or suitability for any purpose of the file, information or specifications. You are solely responsible for the use of the file, information, or specifications.

This document is the property of Aspen Fasteners Inc. and the information it contains may not be reproduced, disclosed, or shared with any third party without the expressed written permission of Aspen Fasteners Inc.

SCALE 2.084

PRODUCT NAME
M12-1.0 DIN 439B, Metric,
Hex Jam Thin Nuts, A2 Stainless Steel

PART NUMBER: ME235-1210X6X19

UNIT
MILLIMETERS

ISSUED
2025-01-26

SHEET 1 of 1