

Specifications for: #10-32 X 1-1/4" Machine Screws, Flat Countersunk Head Tamper-Resistant Torx Plus(r) Pin Drive, Stainless Steel

Notes:

- Category: Machine Screws
- System of Measurement: Inch
- Head Style: Flat Countersunk Head
- Head Style Detail: 82 Degree Countersink
- Drive Style: Tamper-Resistant 5Lobe Pin Drive
- Drive Detail: Torx Plus(r) Brand
- Thread Length: Full Thread
- Thread Direction: Right-Hand Thread
- Material: Stainless Steel
- Material Grade: 302 Stainless Steel
- Coating: Uncoated
- Origin: Made in U.S.A.

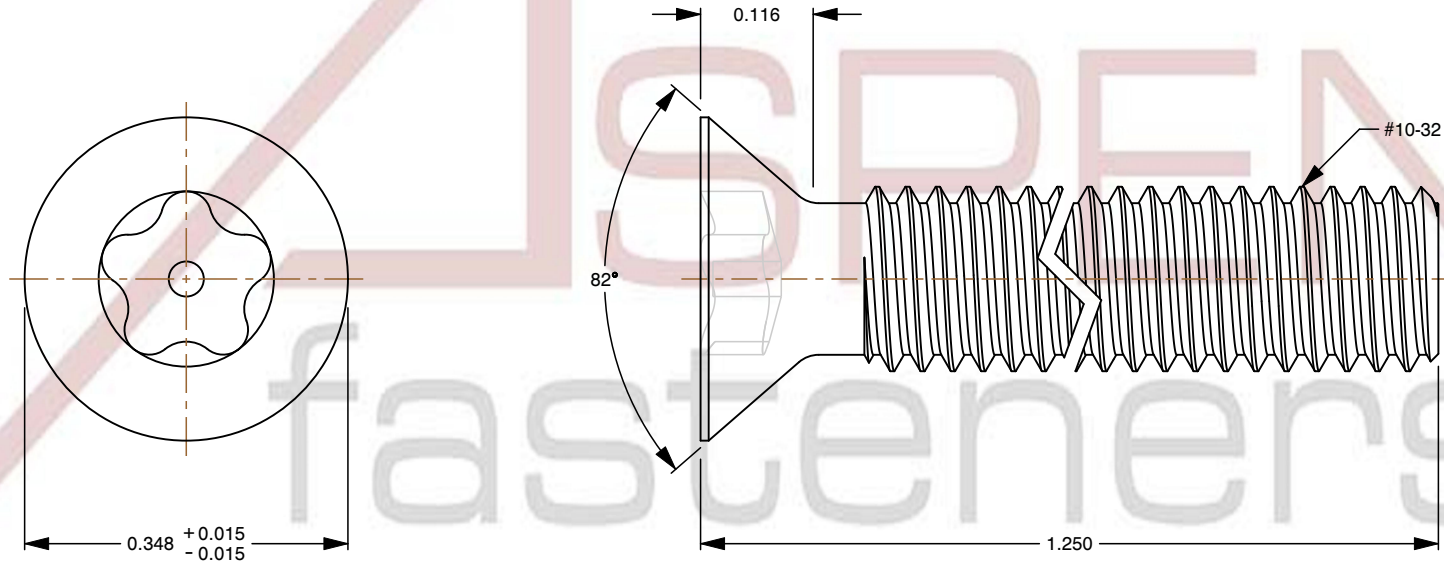
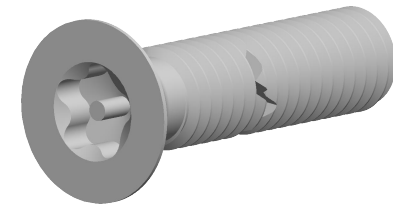

This file and any associated information and specifications are provided for reference and evaluation purposes only and is subject to change without notice. Aspen Fasteners Inc. makes no representations, warranties, or guarantees as to the appropriateness, accuracy, completeness, or suitability for any purpose of the file, information or specifications. You are solely responsible for the use of the file, information, or specifications.

This document is the property of Aspen Fasteners Inc. and the information it contains may not be reproduced, disclosed, or shared with any third party without the expressed written permission of Aspen Fasteners Inc.

SCALE 5.056

PRODUCT NAME
#10-32 X 1-1/4" Machine Screws, Flat Countersunk
Head Tamper-Resistant Torx Plus(r) Pin Drive,
Stainless Steel

PART NUMBER: TR038-1032X11425

UNIT
INCHES

ISSUED
2026-06-03

SHEET 1 of 1