

**Specifications for: #6-32 X 1-1/2" Security Machine Screws, Flat Countersunk Head Tamper Resistant Hex Socket Pin Drive, Alloy Steel, Includes Driver Bit**

**Notes:**

- Category: Machine Screws
- System of Measurement: Inch
- Head Style: Flat Countersunk Head
- Head Style Detail: 82 Degree Countersink
- Drive Style: Tamper-Resistant Hex Socket Pin Drive
- Thread Length: Full Thread
- Thread Direction: Right-Hand Thread
- Material: Steel
- Material Grade: Alloy Steel
- Coating: Uncoated
- Origin: Made in U.S.A.

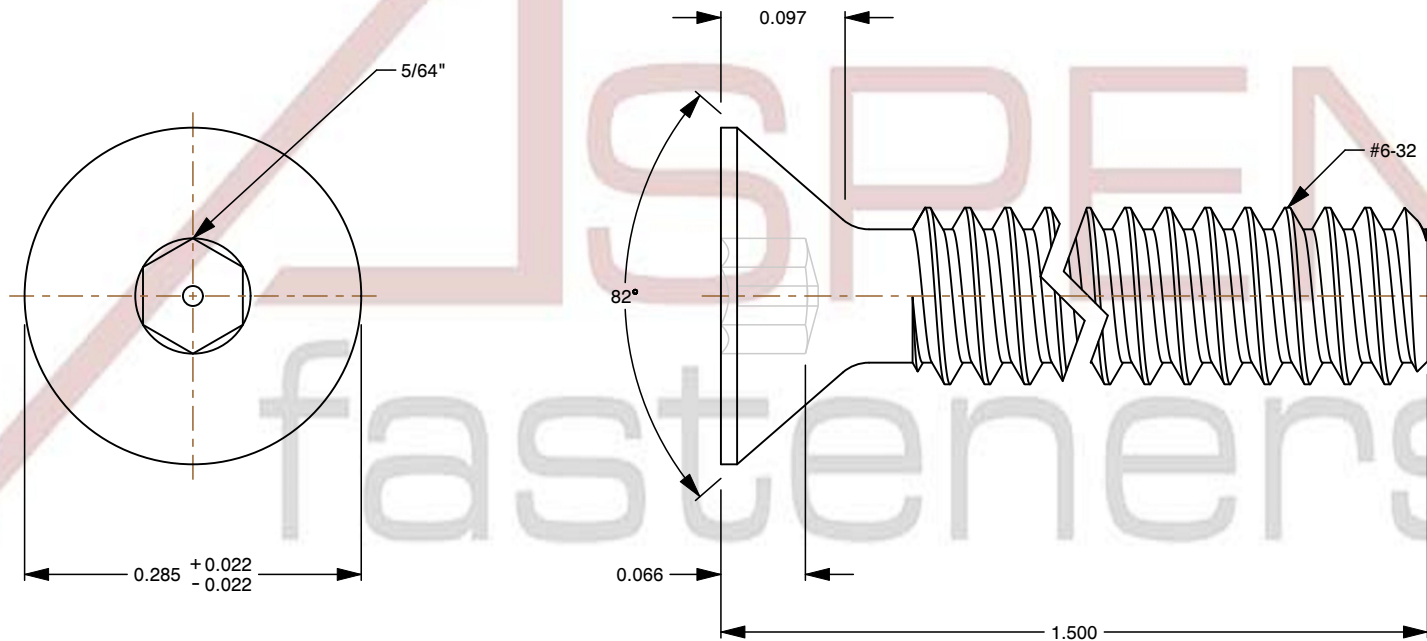
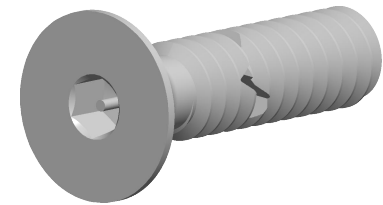

This file and any associated information and specifications are provided for reference and evaluation purposes only and is subject to change without notice. Aspen Fasteners Inc. makes no representations, warranties, or guarantees as to the appropriateness, accuracy, completeness, or suitability for any purpose of the file, information or specifications. You are solely responsible for the use of the file, information, or specifications.

This document is the property of Aspen Fasteners Inc. and the information it contains may not be reproduced, disclosed, or shared with any third party without the expressed written permission of Aspen Fasteners Inc.

SCALE 6.667

PRODUCT NAME  
#6-32 X 1-1/2" Security Machine Screws, Flat Countersunk Head Tamper Resistant Hex Socket Pin Drive, Alloy Steel, Includes Driver Bit

PART NUMBER: TR040-632X11218

UNIT  
INCHES

ISSUED  
2026-06-03

SHEET 1 of 1