

**Specifications for: #4 X 1/8" Round Spacers, 1/4" Diameter, Aluminum, Made in U.S.A.**

Notes:

- Category: Round Spacers
- Form and Design: 1/4" Diameter
- System of Measurement: Inch
- Head Style: Headless
- Drive Style: No Drive Defined
- Material: Aluminum
- Material Grade: Standard Commercial Grade
- Coating: Uncoated
- Origin: Made in U.S.A.

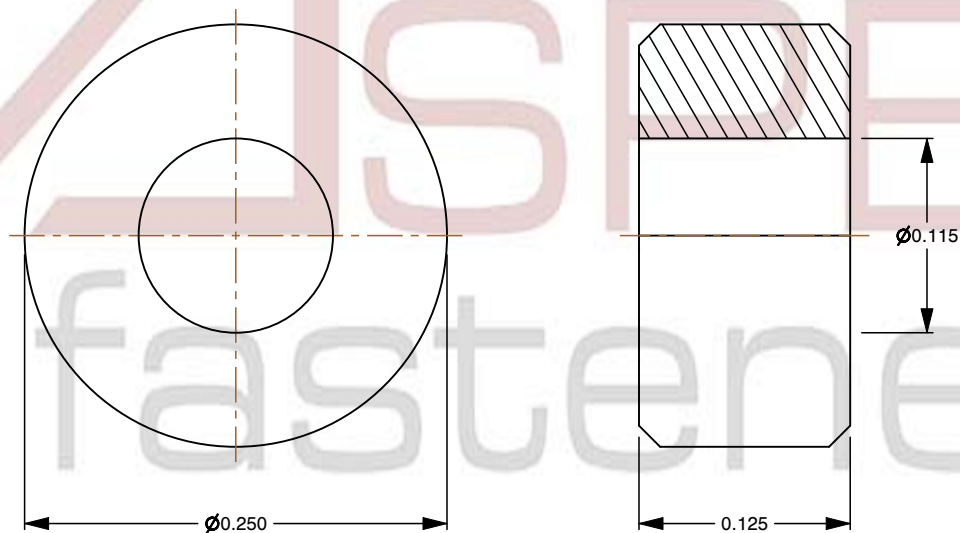
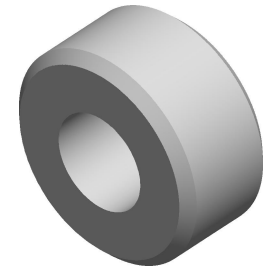

This file and any associated information and specifications are provided for reference and evaluation purposes only and is subject to change without notice. Aspen Fasteners Inc. makes no representations, warranties, or guarantees as to the appropriateness, accuracy, completeness, or suitability for any purpose of the file, information or specifications. You are solely responsible for the use of the file, information, or specifications.

This document is the property of Aspen Fasteners Inc. and the information it contains may not be reproduced, disclosed, or shared with any third party without the expressed written permission of Aspen Fasteners Inc.

SCALE 8.800

PRODUCT NAME  
#4 X 1/8" Round Spacers,  
1/4" Diameter, Aluminum, Made in U.S.A.

PART NUMBER: FC024-4X18

UNIT  
INCHES

ISSUED  
2025-02-20

SHEET 1 of 1