

Specifications for: #8-32 X 9/16" Hex Male-Female Standoffs, 1/4" Across Flats, Brass, Nickel Plated, Made in U.S.A.

Notes:

- Category: Hex Male-Female Standoffs
- Form and Design: 1/4" Across Flats
- System of Measurement: Inch
- Head Style: Headless
- Drive Style: External Hex Drive
- Thread Direction: Right-Hand Thread
- Material: Brass
- Coating: Nickel Plated
- Origin: Made in U.S.A.

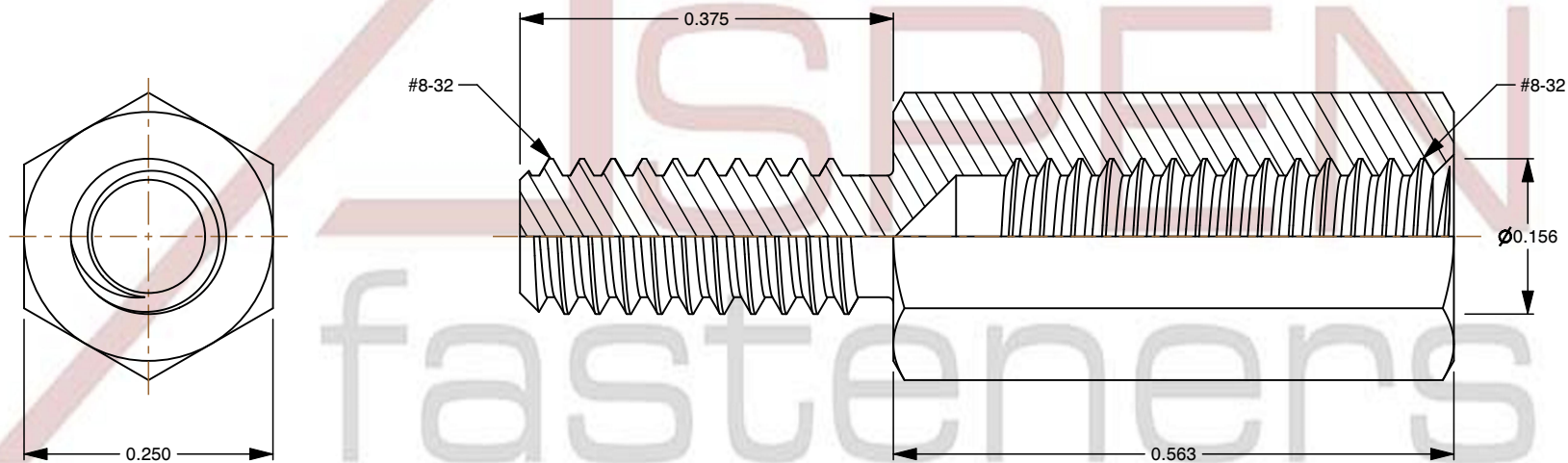
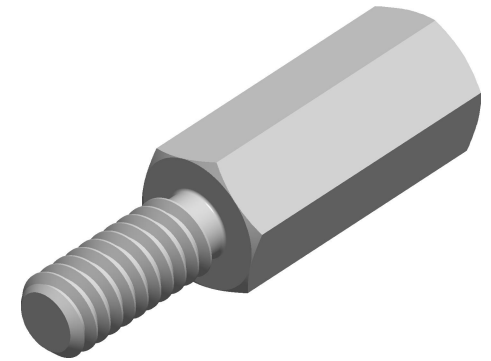

This file and any associated information and specifications are provided for reference and evaluation purposes only and is subject to change without notice. Aspen Fasteners Inc. makes no representations, warranties, or guarantees as to the appropriateness, accuracy, completeness, or suitability for any purpose of the file, information or specifications. You are solely responsible for the use of the file, information, or specifications.

This document is the property of Aspen Fasteners Inc. and the information it contains may not be reproduced, disclosed, or shared with any third party without the expressed written permission of Aspen Fasteners Inc.

SCALE 5.387

PRODUCT NAME
#8-32 X 9/16" Hex Male-Female Standoffs,
1/4" Across Flats, Brass, Nickel Plated,
Made in U.S.A.

PART NUMBER: FC019-832X916

UNIT
INCHES

ISSUED
2025-01-26

SHEET 1 of 1