

**Specifications for: M4-0.7 X 19mm Hex Male-Female Standoffs, Metric, 6mm Across Flats, Stainless Steel, Made in U.S.A.**

**Notes:**

- Category: Hex Male-Female Standoffs
- Form and Design: 6mm Across Flats
- System of Measurement: Metric
- Head Style: Headless
- Drive Style: External Hex Drive
- Thread Direction: Right-Hand Thread
- Material: Stainless Steel
- Coating: Uncoated
- Origin: Made in U.S.A.

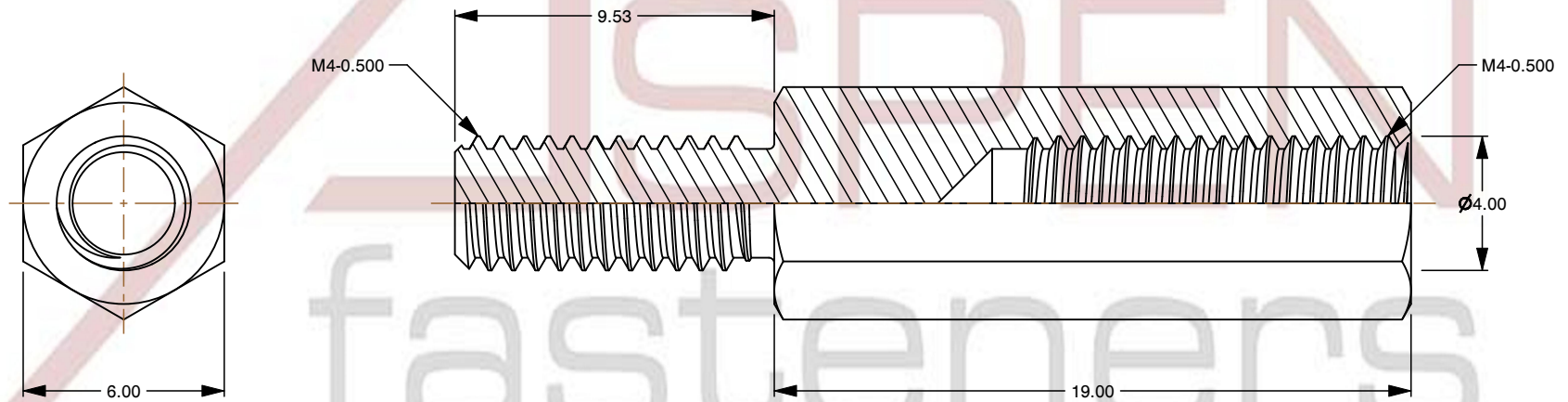
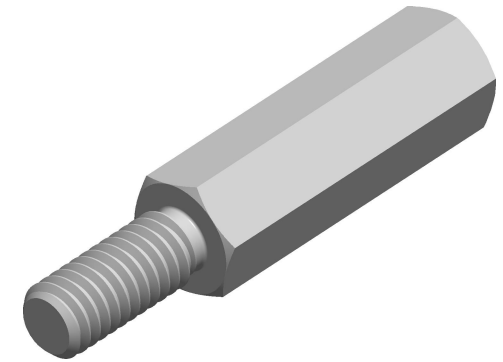

This file and any associated information and specifications are provided for reference and evaluation purposes only and is subject to change without notice. Aspen Fasteners Inc. makes no representations, warranties, or guarantees as to the appropriateness, accuracy, completeness, or suitability for any purpose of the file, information or specifications. You are solely responsible for the use of the file, information, or specifications.

This document is the property of Aspen Fasteners Inc. and the information it contains may not be reproduced, disclosed, or shared with any third party without the expressed written permission of Aspen Fasteners Inc.

**PRODUCT NAME**  
M4-0.7 X 19mm Hex Male-Female Standoffs,  
Metric, 6mm Across Flats, Stainless Steel,  
Made in U.S.A.

**UNIT**  
MILLIMETERS

**ISSUED**  
2025-01-26

**SCALE** 4.781

**PART NUMBER:** FC037-4070X19

**SHEET** 1 of 1